

REFACCIONES



Vasos Y Protecciones

S Series - Estándar Filtros



● SF200

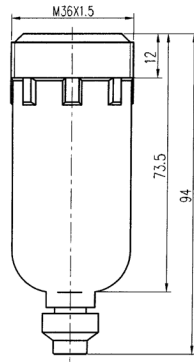

● SF200-WC

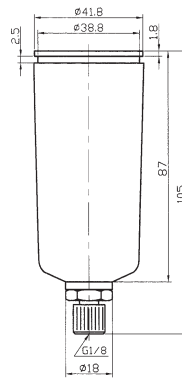

● SF400-WC

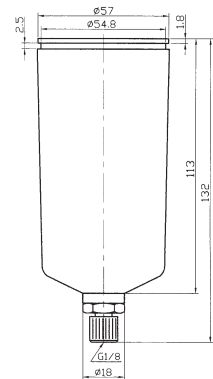

● SF500-WC

REFACCIONES PARA FILTROS (S SERIES)

Vaso para filtro SF200-WC	Vaso para filtro SF300-WC	Vaso para filtro SF400-WC	Vaso para filtro SF500-WC
Para Modelos	Para Modelos	Para Modelos	Para Modelos
SC200-02	SC300-03	SC400-04	SC500-10/06
SC201-02	SC301-03	SC401-04	SC501-10/06
SW200-02	SW300-03	SW400-04	SW500-10/06
SF200-02	SF300-03	SF400-04	SF500-10/06

Lubricadores



● SL300 - OC

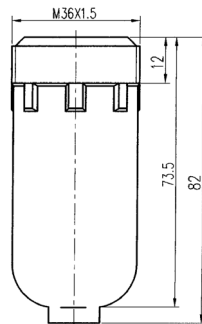

● SL500 - OC

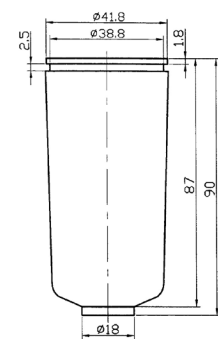

REFACCIONES PARA LUBRICADORES (S SERIES)

Vaso para Lubricador SL200-OC	Vaso para Lubricador SL230-OC	Vaso para Lubricador SL400-OC	Vaso para Lubricador SL500-OC
Para Modelos	Para Modelos	Para Modelos	Para Modelos
SC200-02	SC300-03	SC400-04	SC500-10/06
SC201-02	SC301-03	SC401-04	SC501-10/06
SL200-02	SL300-03	SL400-04	SL500-10/06

Vasos Y Protecciones

S Series - Metálico Filtros

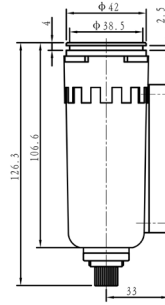
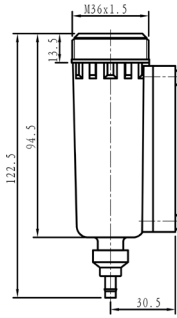
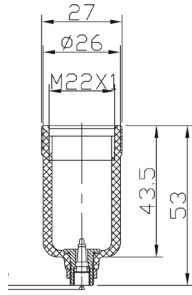

■ SF100 - WC-DM

■ SF100 - WC-M

■ SF200

■ SF300

REFACCIONES PARA FILTROS (S SERIES) VASO METÁLICO MANUAL

Vaso para filtro SF100-WC-M	Vaso para filtro SF200-WC-M	Vaso para filtro SF300-WC - M	Vaso para filtro SF400-WC - M	Vaso para filtro SF500-WC - M
Para Modelos	Para Modelos	Para Modelos	Para Modelos	Para Modelos
SC100-M5	SC200-02	SC300-03	SC400-04	SC500-10/06
SC101-M5	SC201-02	SC301-03	SC401-04	SC501-10/06
SW100-M5	SW200-02	SW300-03	SW400-04	SW500-10/06
SF100-M5	SF200-02	SF300-03	SF400-04	SF500-10/06

REFACCIONES PARA FILTROS (S SERIES) VASO METÁLICO AUTOMÁTICO

Vaso para filtro SF100-WC-DM	Vaso para filtro SF200-WC-DM	Vaso para filtro SF300-WC - DM	Vaso para filtro SF400-WC - DM	Vaso para filtro SF500-WC - DM
Para Modelos	Para Modelos	Para Modelos	Para Modelos	Para Modelos
SC100-M5	SC200-02	SC300-03	SC400-04	SC500-10/06
SC101-M5	SC201-02	SC301-03	SC401-04	SC501-10/06
SW100-M5	SW200-02	SW300-03	SW400-04	SW500-10/06
SF100-M5	SF200-02	SF300-03	SF400-04	SF500-10/06

Vasos Y Protecciones

S Series - Metálico Lubricadores

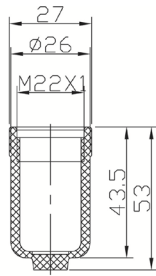

■ SL100 - OC-M

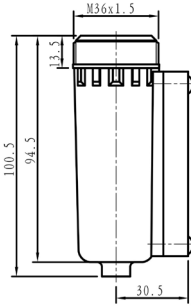

■ SL200

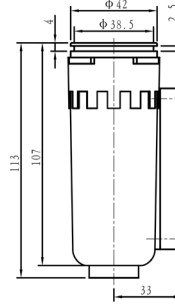

■ SL300

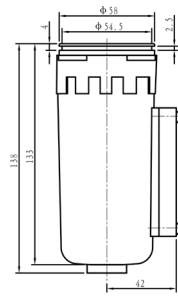

■ SL400

REFACCIONES PARA LUBRICADORES (S SERIES) VASO METÁLICO

Vaso para Lubricador SL200-OC - M	Vaso para Lubricador SL230-OC - M	Vaso para Lubricador SL400-OC - M	Vaso para Lubricador SL500-OC - M
Para Modelos	Para Modelos	Para Modelos	Para Modelos
SC200-02	SC300-03	SC400-04	SC500-10/06
SC201-02	SC301-03	SC401-04	SC501-10/06
SL200-02	SL300-03	SL400-04	SL500-10/06

E Series Filtros

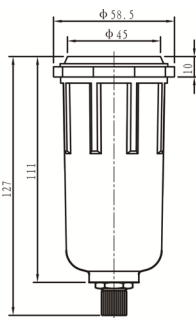

■ EF400

REFACCIONES PARA FILTROS (E SERIES)

Vaso para filtro EF150-WC	Vaso para filtro EF200-WC	Vaso para filtro EF300-WC	Vaso para filtro EF400-WC
Para Modelos	Para Modelos	Para Modelos	Para Modelos
EF1500	EF2000	EF3000	EF4000
EFR1500	EFR2000	EFR3000	EFR4000
EFC1500	EFC2000	EFC3000	EFC4000
EFC1500	EFC2000	EFC3000	EFC4000

Lubricadores

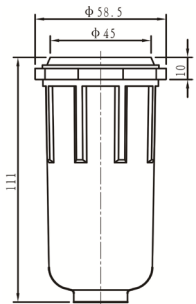

■ EL400

REFACCIONES PARA LUBRICADORES (E SERIES)

Vaso para Lubricador EL150-OC	Vaso para Lubricador EL200-OC	Vaso para Lubricador EL300-OC	Vaso para Lubricador EL400-OC
Para Modelos	Para Modelos	Para Modelos	Para Modelos
EL1500	EL2000	EL3000	EL4000
EFC1500	EFC2000	EFC3000	EFC4000
EC1500	EC2000	EC3000	EC4000

Vasos Y Protecciones

X Series - Metálico

Filtros

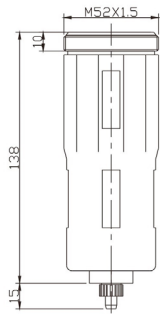

■ XF-15-MIDI

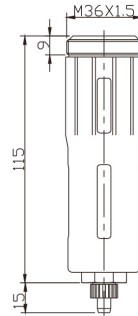

■ XF-08-MINI

REFACCIONES PARA FILTROS (X SERIES)

Vaso para filtro XF-06-WC	Vaso para filtro XF-08-WC	Vaso para filtro XF-10-WC	Vaso para filtro XF-15-WC	Vaso para filtro XF-20-WC	Vaso para filtro XF-25-WC
Para Modelos	Para Modelos	Para Modelos	Para Modelos	Para Modelos	Para Modelos
XF-06-MINI	XF-08-MINI	XF-10-MIDI	XF-15-MIDI	XF-20-MAXI	XF-25-MAXI
XFR-06-MINI	XFR-08-MINI	XFR-10-MIDI	XFR-15-MIDI	XFR-20-MAXI	XFR-25-MAXI
XFC-06-MINI	XFC-08-MINI	XFC-10-MIDI	XFC-15-MIDI	XFC-20-MAXI	XFC-25-MAXI
XC-06-MINI	XC-08-MINI	XC-10-MIDI	XC-15-MIDI	XC-20-MAXI	XC-25-MAXI

Lubricadores

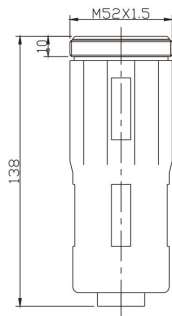

■ XL-15-MIDI

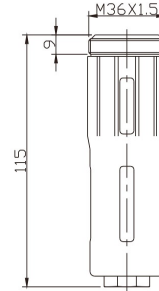









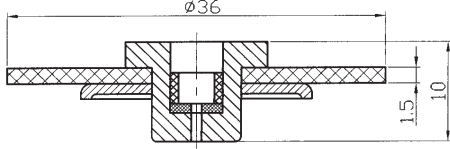

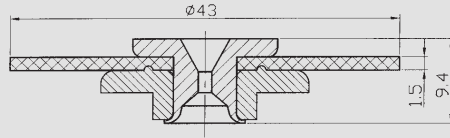
■ XL-08-MINI

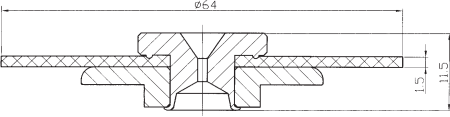
REFACCIONES PARA LUBRICADORES (X SERIES)

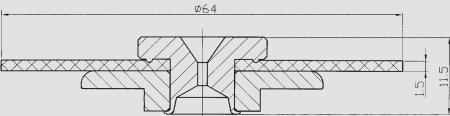
Vaso para lubricador XL-06-OC	Vaso para lubricador XL-08-OC	Vaso para lubricador XL-10-OC	Vaso para lubricador XL-15-OC	Vaso para lubricador XL-20-OC	Vaso para lubricador XL-25-OC
Para Modelos	Para Modelos	Para Modelos	Para Modelos	Para Modelos	Para Modelos
XL-06-MINI	XL-08-MINI	XL-10-MIDI	XL-15-MIDI	XL-20-MAXI	XL-25-MAXI
XFC-06-MINI	XFC-08-MINI	XFC-10-MIDI	XFC-15-MIDI	XFC-20-MAXI	XFC-25-MAXI
XC-06-MINI	XC-08-MINI	XC-10-MIDI	XC-15-MIDI	XC-20-MAXI	XC-25-MAXI

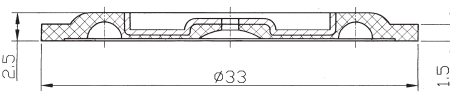
Diafragmas

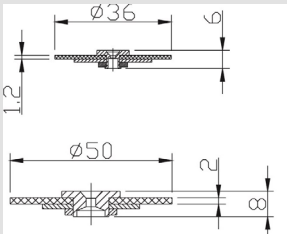
REFACCIÓN			
No. PARTE	IMAGEN	ESTRUCTURA	MODELOS QUE APLICA
SR200-DIA			"SC200-02 SC201-02 SR200-02 SW200-02"
SR300-DIA			"SC300-03 SC301-03 SR300-03 SW300-03"
SR400-DIA			"SC400-04 SC401-04 SR400-04 SW400-04"
SR500-DIA			"SC500-05 SC501-05 SR500-05 SW500-05"
ER200-DIA			Cualquier Regulador (E series)
"XR-08-DIA XR-15-DIA"			Cualquier Regulador (X series)

SC Series



SC200 SERIES

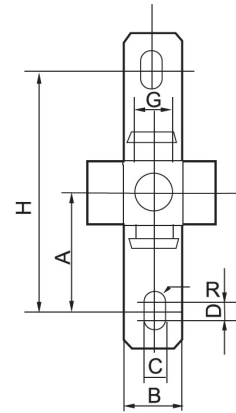
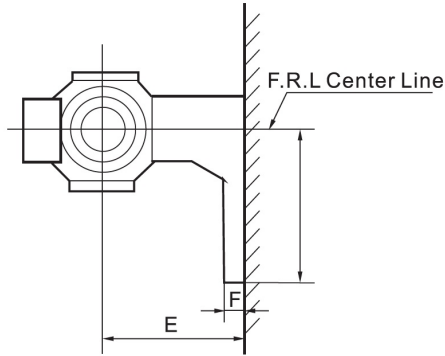

MODELO	A	B	C	D	E	F	G	R	L
SC200-01	24	15	5.5	3	30	5	10	2.75	33
SC200-02	24	15	5.5	3	30	5	10	2.75	33
SC300-02	35	16	7	4	41	7	11	3.5	45
SC300-03	35	16	7	4	41	7	11	3.5	45
SC400-04	40	22	9	4	50	7	14	4.5	50
SC500-06	50	23	12	4	69.8	10.5	15	6	63
SC500-10	50	23	12	4	69.8	10.5	15	6	63



SC201 SERIES

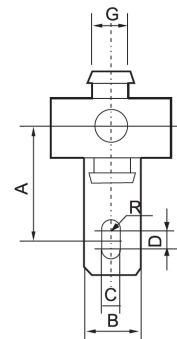
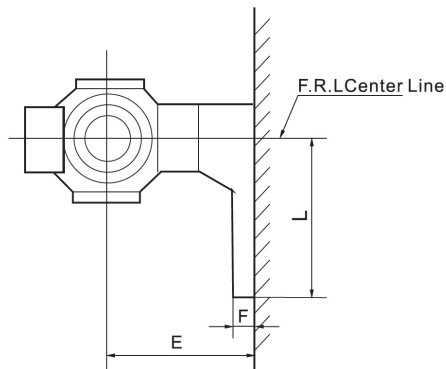

MODELO	A	B	C	D	E	F	G	H	R	L
SC201-01	24	15	5.5	3	30	5	10	48	2.75	33
SC201-02	24	15	5.5	3	30	5	10	48	2.75	33
SC301-02	35	16	7	4	41	7	11	70	3.5	45
SC301-03	35	16	7	4	41	7	11	70	3.5	45
SC401-04	40	22	9	4	50	7	14	80	4.5	50
SC501-06	50	23	12	4	69.8	10.5	15	100	6	63
SC501-10	50	23	12	4	69.8	10.5	15	100	6	63

Soporte

SR Series



SR SERIES

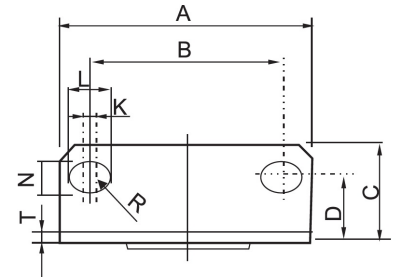
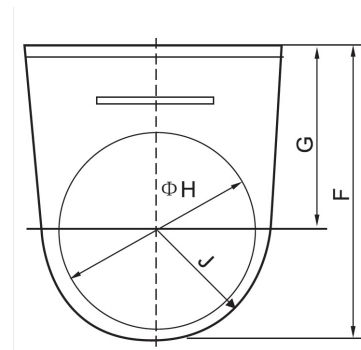

MODELO	A	B	C	D	F	G	ØH	J	K	L	N	R	T
SR200-BRS	55	34	25	19	50	30	33.5	20	1	15.4	5.4	2.7	2.3
SR300-BRS	53	40	21.5	14	64	39	42.5	25	1.5	8	6.5	3.25	2.3
SR400-BRS	70	54	27	18	79.2	49.2	52.5	30	2	10.5	8.5	4.26	2.3
SR500-BRS	70	54	27	18	79.2	49.2	52.5	30	2	10.5	8.5	4.26	2.3

EC Series



EC SERIES

EFC Series



SC200 SERIES

X Series



SR SERIES

Soportes EC Series

EC150-BR

EC200-BR

EC300-BR

EC400-BR

Soportes EFC Series

EFC150-BR

EFC200-BR

EFC300-BR

EFC400-BR

Soportes X Series

XF-06/08-BR

XF-10/15-BR

XF-20/25-BR

Elementos Filtrantes

Plástico



Elemento Filtrante	Filtracion	Material
SF200-05PFE	5 micras	Plástico
SF300-05PFE	5 micras	Plástico
SF400-05PFE	5 micras	Plástico
SF500-05PFE	5 micras	Plástico
SF200-40PFE	40 micras	Plástico
SF300-40PFE	40 micras	Plástico
SF400-40PFE	40 micras	Plástico
SF500-40PFE	40 micras	Plástico

Bronce



Elemento Filtrante	Filtracion	Material
SF200-05BFE	5 micras	Bronce
SF300-05BFE	5 micras	Bronce
SF400-05BFE	5 micras	Bronce
SF500-05BFE	5 micras	Bronce
SF200-40BFE	40 micras	Bronce
SF300-40BFE	40 micras	Bronce
SF400-40BFE	40 micras	Bronce
SF500-40BFE	40 micras	Bronce

Dispensador de Aceite

EL-OLG



■ EL-OLG

E series

EL150-OLG

EL200-OLG

EL300-OLG

EL400-OLG

SL-OLG



■ SL-OLG

S Series

SL200-OLG

SL300-OLG

SL400-OLG

SL400-OLG